

Report on the NSSMC Oita Works' Fire Accident in its Plate Mill - The cause and preventive measures -

May 18, 2017

Nippon Steel & Sumitomo Metal Corporation

This document is an English translation of the official Japanese version of the Press Release (the “Official Japanese Version”). This English translation was prepared for your reference, to help you understand what is stated in the Official Japanese Version. In the event of any discrepancy between the Official Japanese Version and the English translation, the Official Japanese Version will prevail.

Introduction

On January 5, 2017, the plate mill on the premises of the Oita Works of Nippon Steel & Sumitomo Metal Corporation (NSSMC) caught fire. We sincerely regret the great trouble, anxiety, and inconvenience caused to the people of the local community, our business partners and those concerned by this accident.

On January 19, 2017, we established the Oita Works Plate Mill Fire Accident Response Committee including outside experts in order to investigate the cause of the fire and consider preventive measures, and have been engaged in deliberation. As the Committee has completed review, we hereby report the cause of the fire and the preventive measures by NSSMC.

Oita Works Production Process (Blast Furnace to Plate Mill)

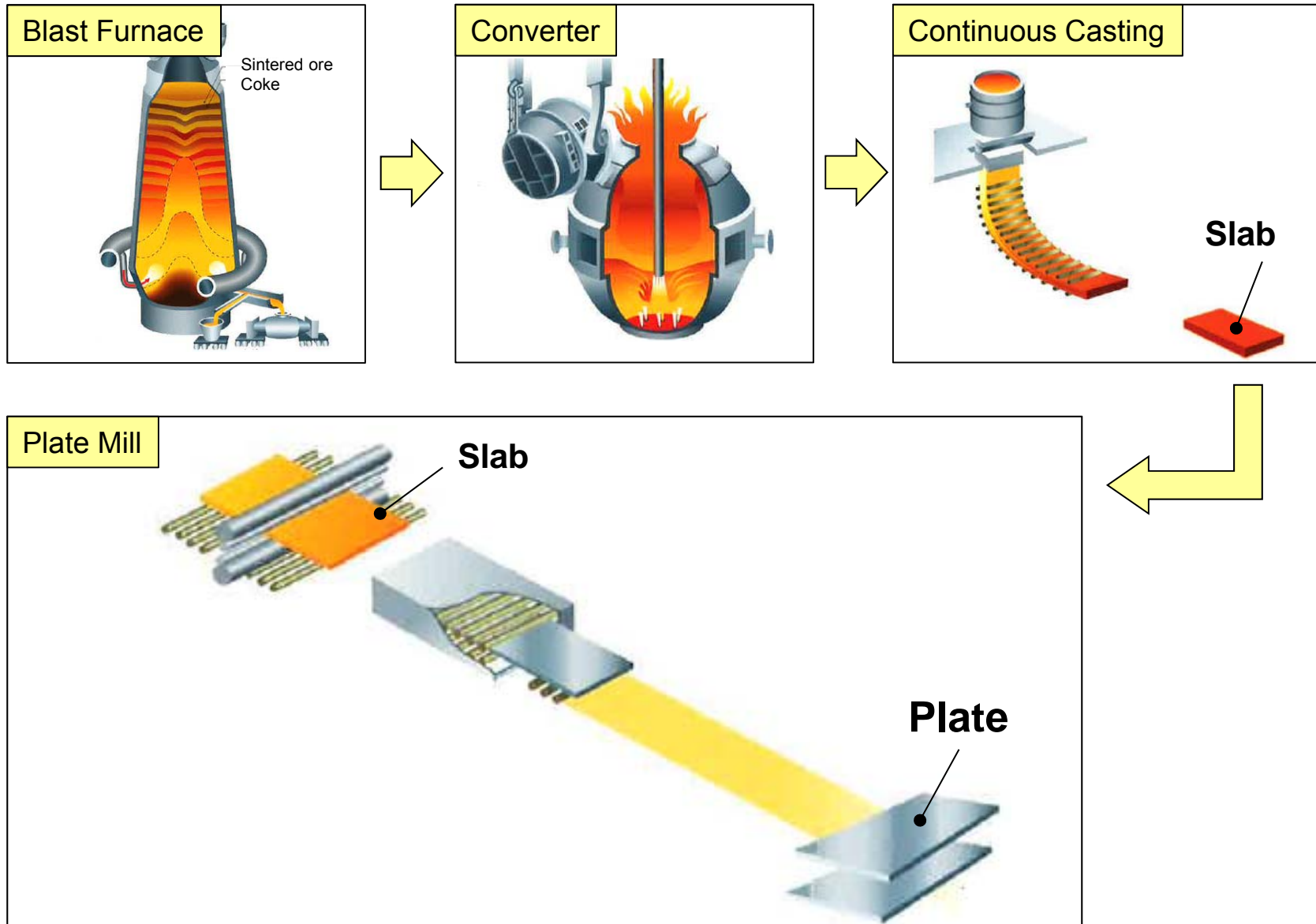

Oita Works Layout Map

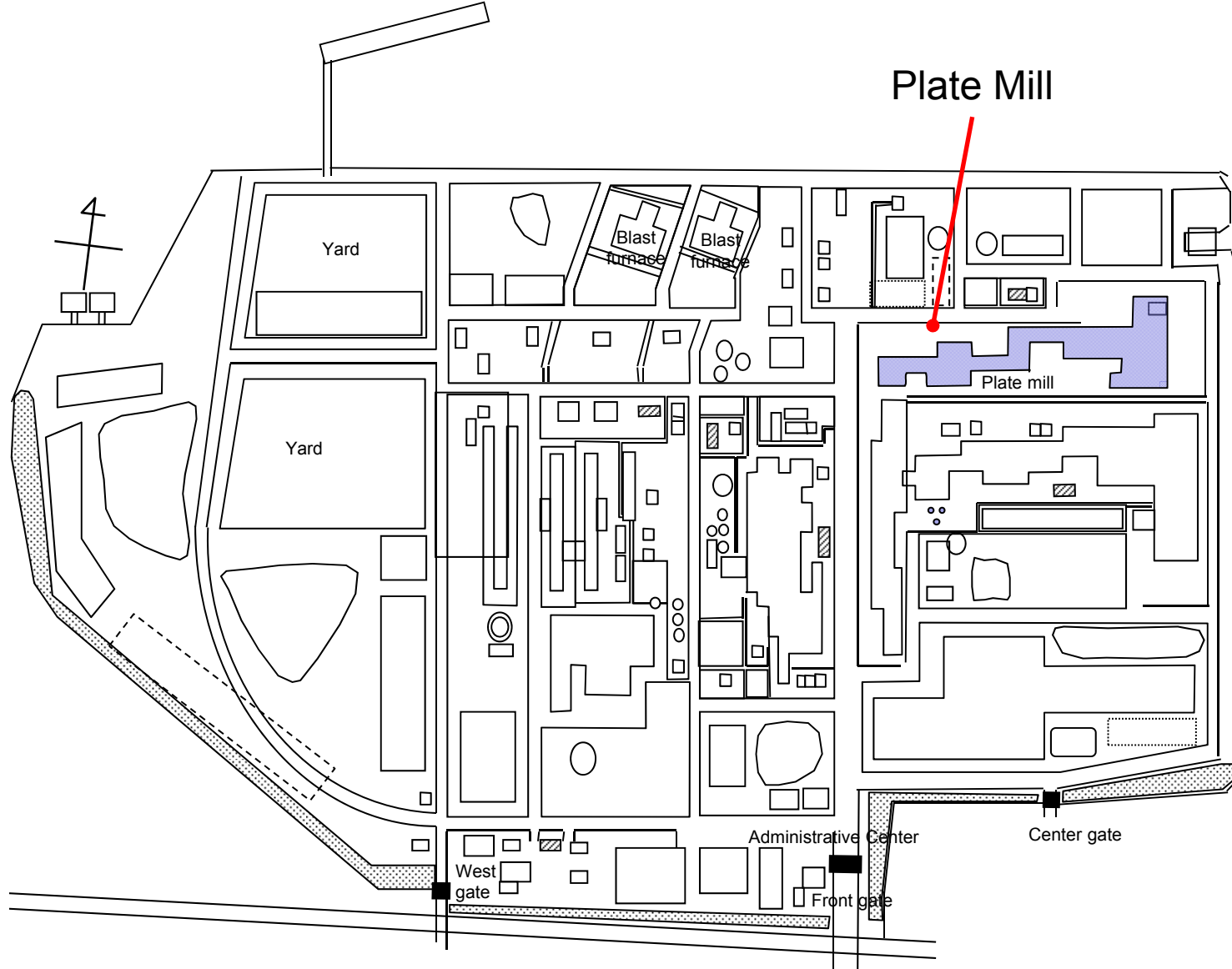

Electrical Room in Plate Mill: Layout of Panels

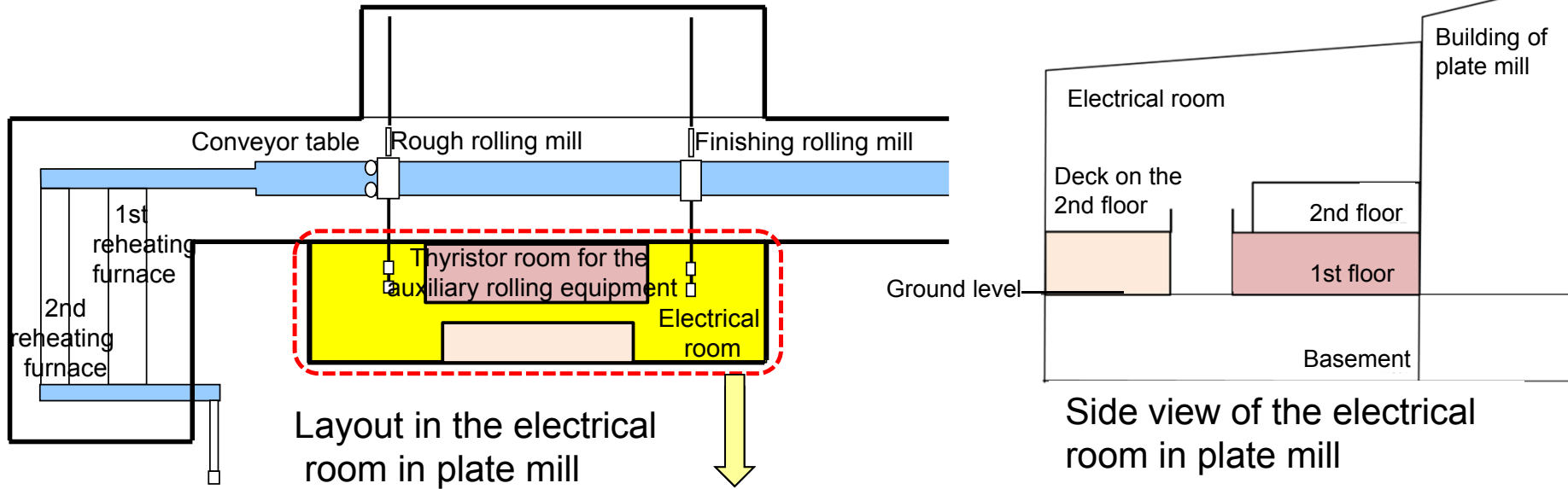

Layout in the electrical room in plate mill

Side view of the electrical room in plate mill

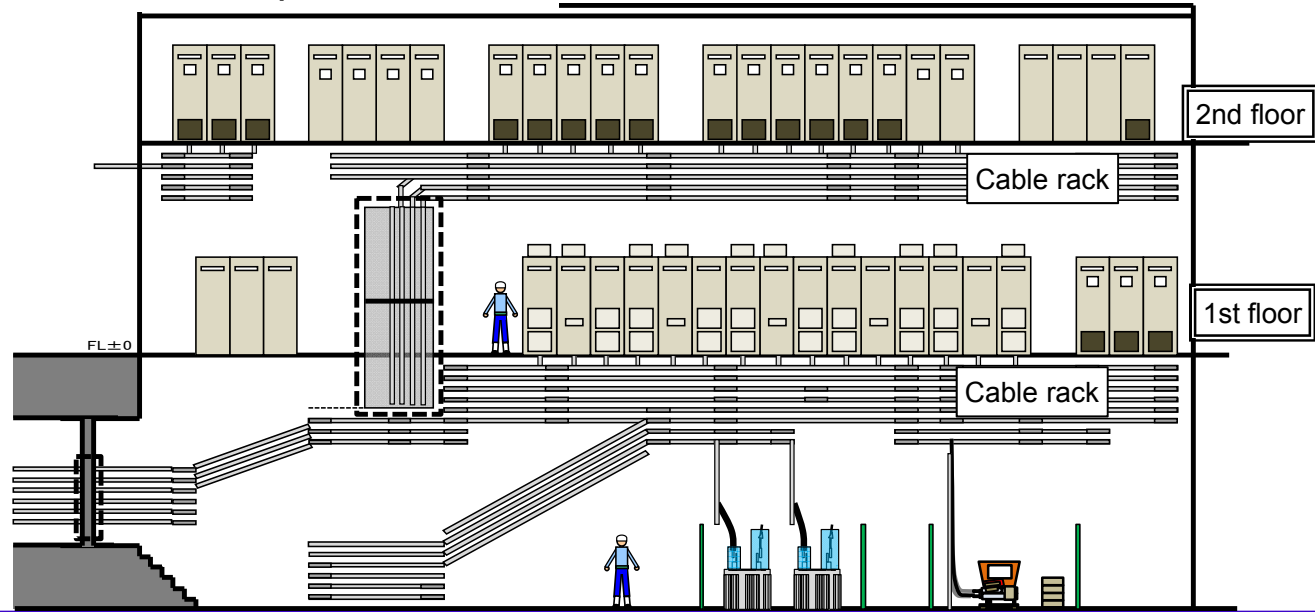

Outline of the Fire

- Where First floor of the electrical room in plate mill
(Thyristor room for the auxiliary rolling equipment)
- When
January 5, 2017
 - 1:27 Warning alarm in the trouble monitoring system went off.
 - About 1:30 Automatic fire alarm went off. Workers saw smoke from the inverter panel in the thyristor room for auxiliary rolling equipment, and started to shut off the electricity to the panel.
 - 1:33 After the electricity was cut, workers attempted to enter the thyristor room for auxiliary rolling equipment to inspect the situation, but without success as the smoke prevented entry.
 - 1:49 The in-house firefighters arrived at site.
 - 2:29 Public firefighters arrived at site.
- January 6, 2017
 - 13:02 The fire was extinguished.

Scope of Damage

- Almost all control panels and cables in the electrical room burned.
- The building of the electrical room was damaged, and part of its floor-supporting steel frames were damaged.
 - The rolling line of the plate mill became inoperable.

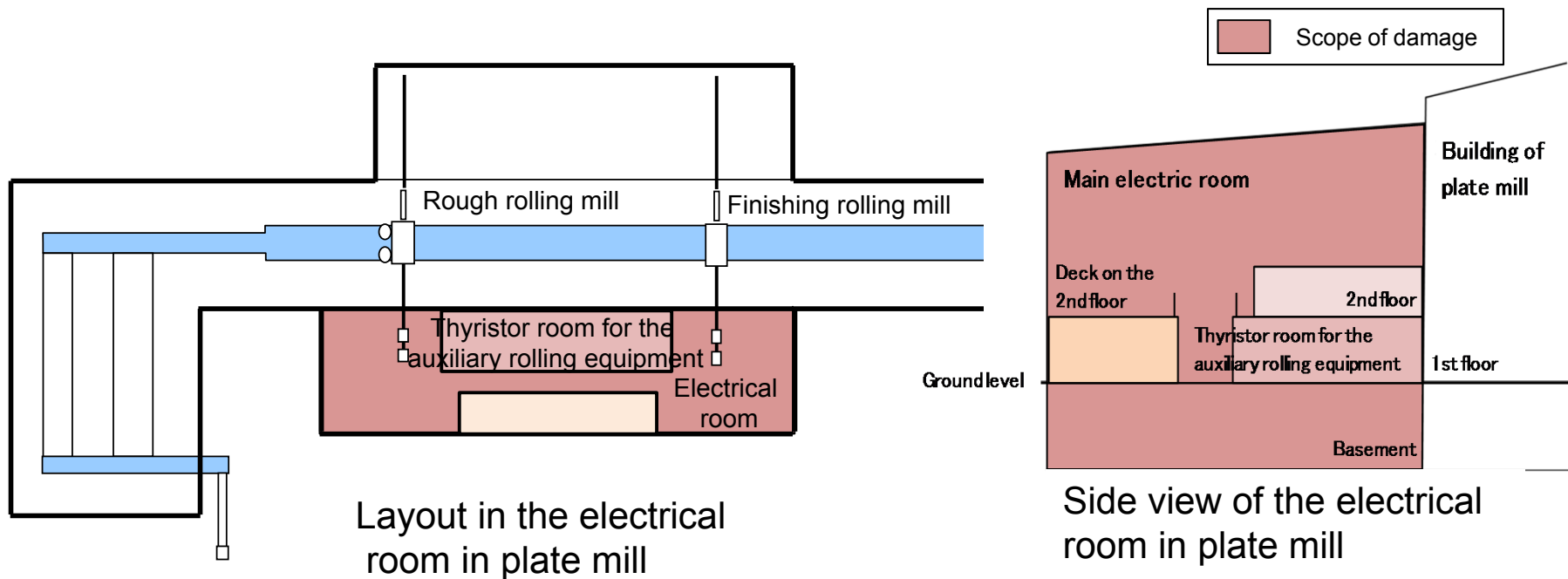

Investigation Results (1)

The Oita Works Plate Mill Fire Accident Response Committee investigated the cause of the fire. Specifically, we inspected the burned equipment and cables, conducted simulation and experiments (for the latter, a mock panel was made to observe how fire was ignited and spread).

<Presumed sequence of ignition and spread of the fire>

1) Abnormality of a device inside a panel in the electrical room caused ignition



2) Flammable materials inside the panel caught fire



3) Fire spread to adjacent panels and cables

Investigation Results(2)

- Presumed origin of the fire:
MC panel for auxiliary rolling equipment (entered operation in 2009)
- This electric panel supplies and controls power (electricity) to a roller that feeds materials to a rolling machine.

MC : Magnetic Contactor

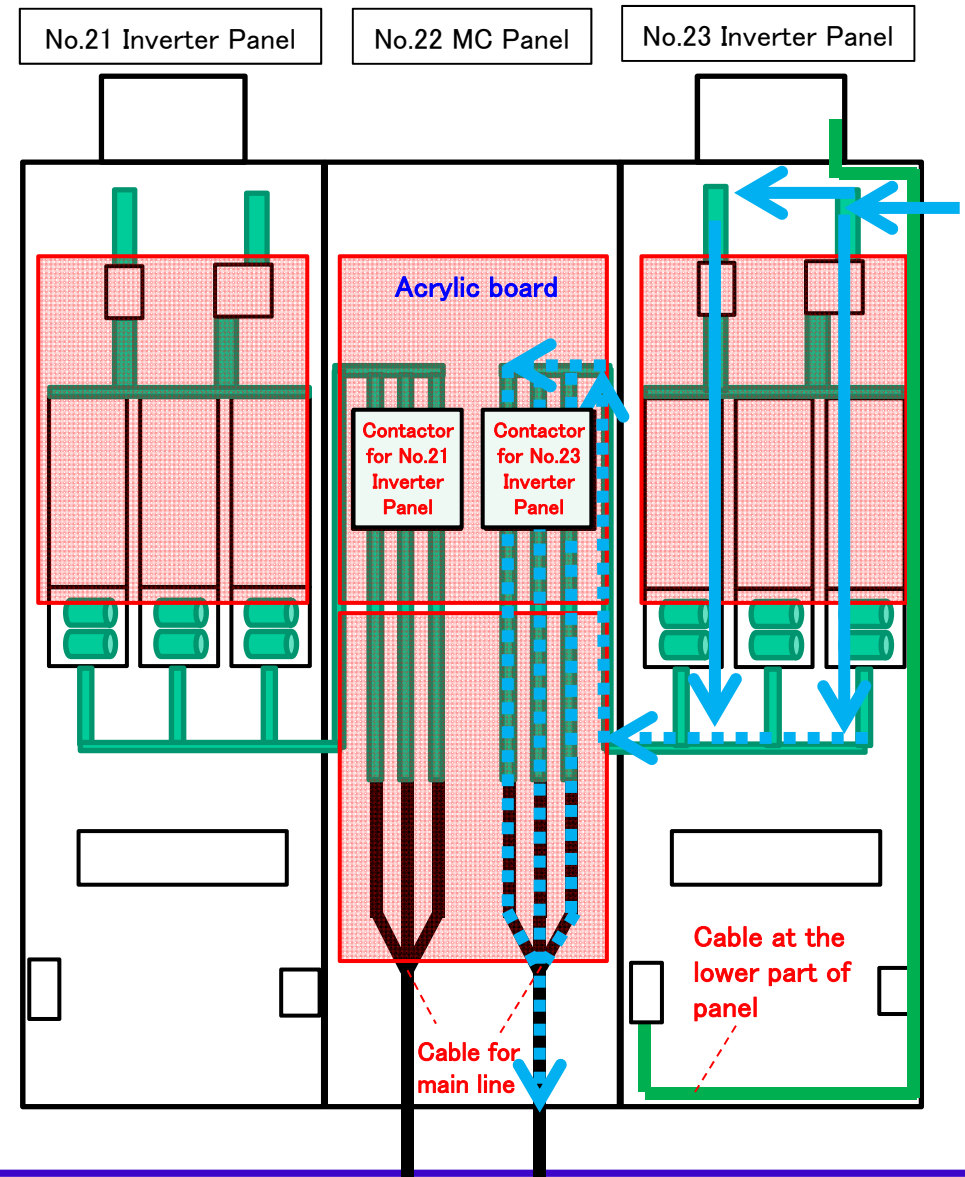

Investigation Results(3)

- Presumed cause of ignition

A control panel that orders a contactor inside the MC panel to open or close output abnormal control signal, and the contactor repeatedly alternated between open and closed while carrying electric current. As a result, arcs occurred continuously from the contactor and ignited flammable components of the panel (acrylic board for prevention of electric shocks, etc).

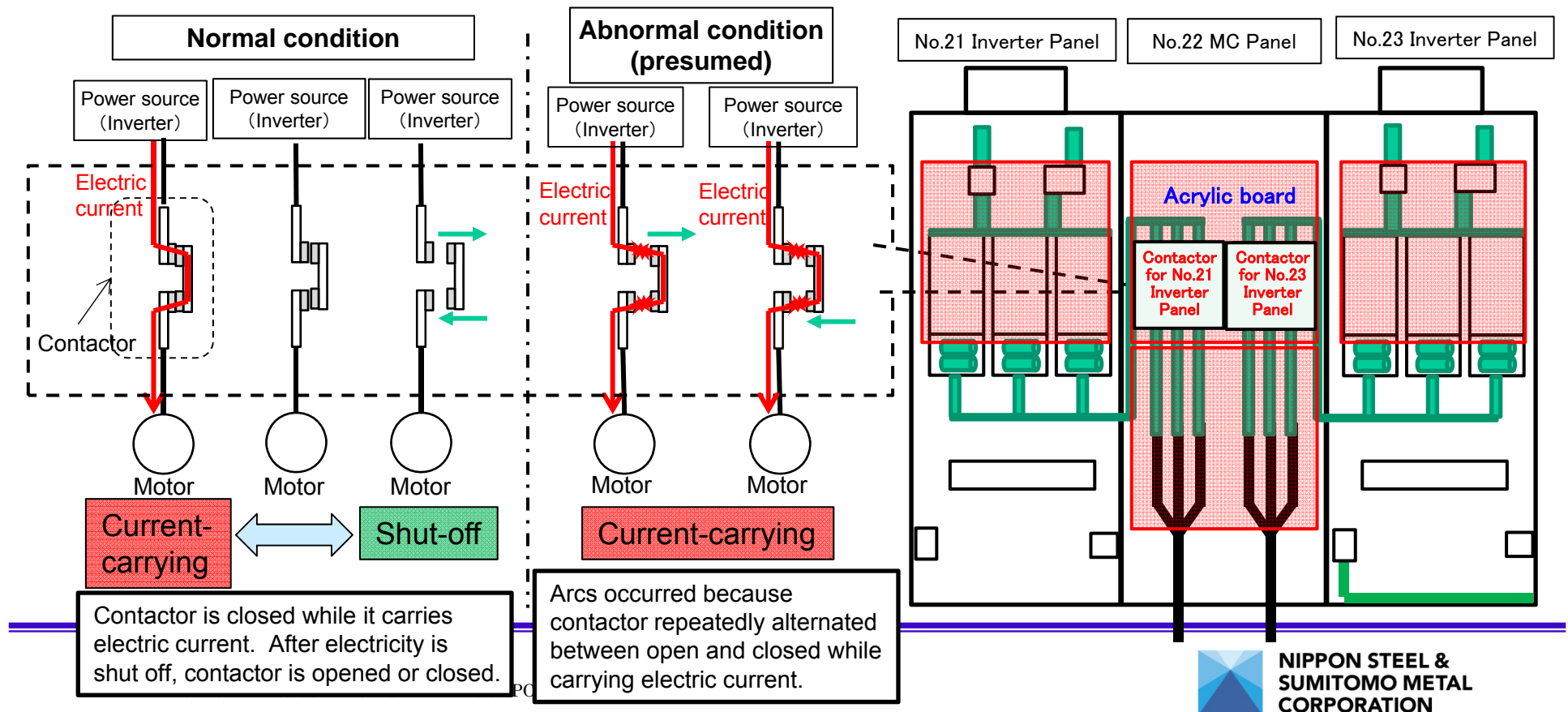

Investigation Results(4)

- Reproduction Experiment

We reproduced the circumstances, which did result in the occurrence of arcs from the contactor and the ignition of flammable components of the panel (acrylic board, etc.)

The experiment using a mock panel



At the start of the experiment



After the ignition

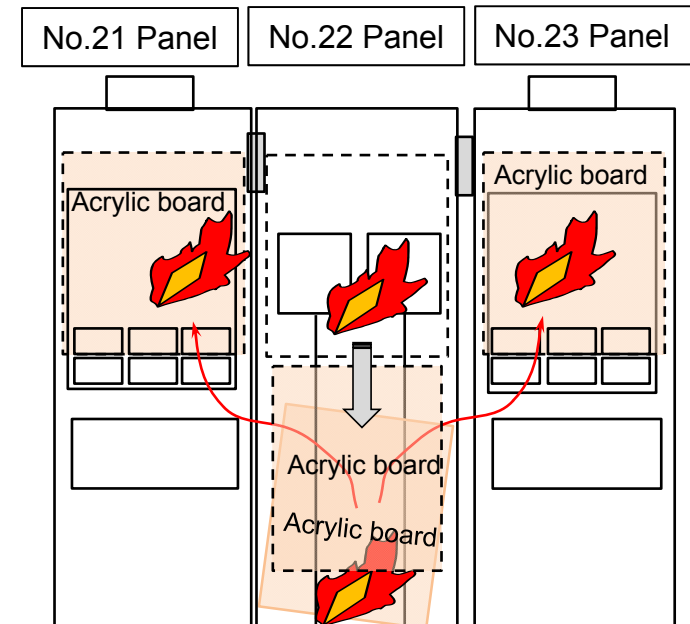

Presumed Cause of the Fire Accident (5)

- Presumed cause of the spread of fire

Flames spread to adjacent panels and cables, and then spread across the entire electrical room from the 1st floor to the 2nd floor, and then to the basement.

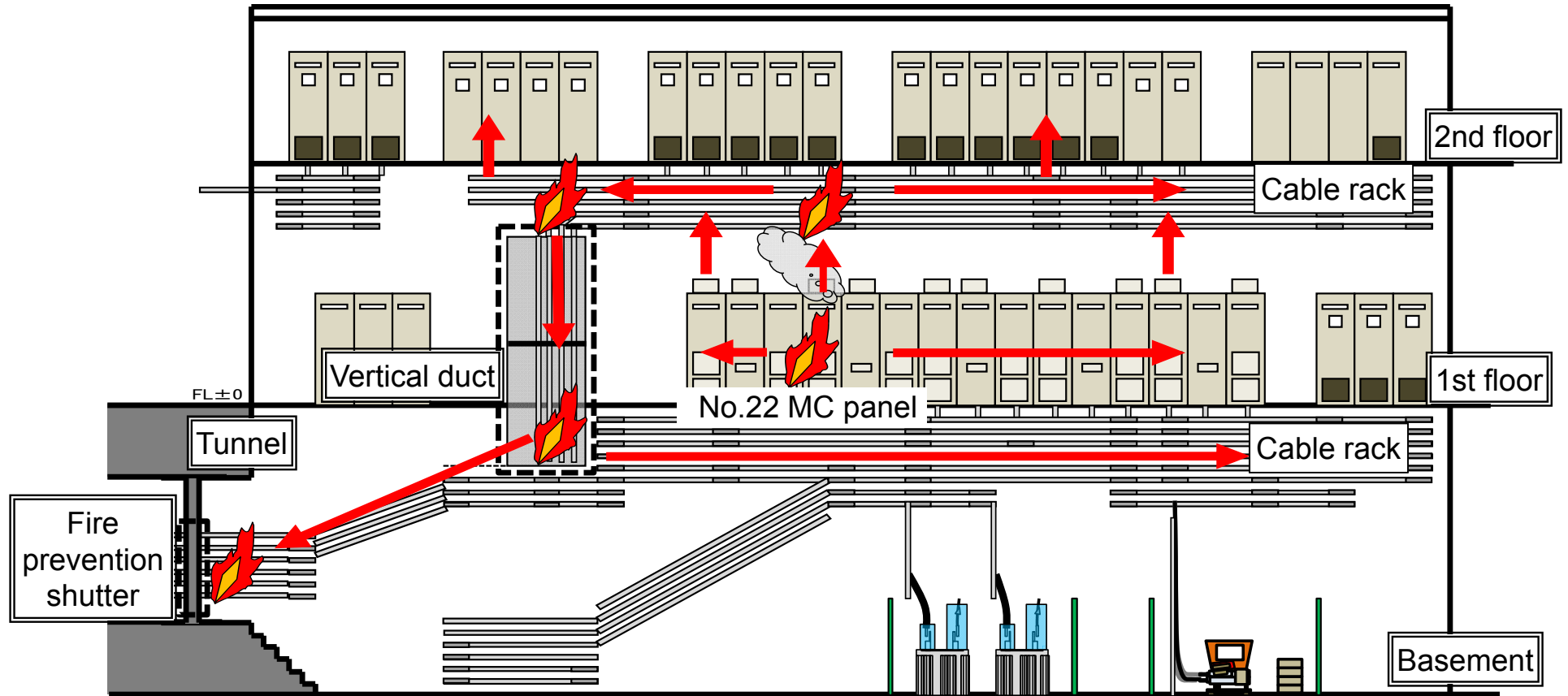

Measures to Prevent Recurrence (Applied to the Electrical Room)

1. Measures to prevent the outbreak of fire

【Measures】

The following measures are being implemented against the presumed cause of the fire (that is, an abnormal control signal from control panel to the contactor and the resultant occurrence of arcs).

- Installation of circuits that shut off electric current in case of the occurrence of abnormal control signal

Measures to Prevent Recurrence (Applied to the Electrical Room)

2. Measures in case of the outbreak of fire

“Triple Actions” are being implemented to prevent recurrence of the presumed cause of the outbreak of fire and address all conceivable factors.



【Triple Actions】

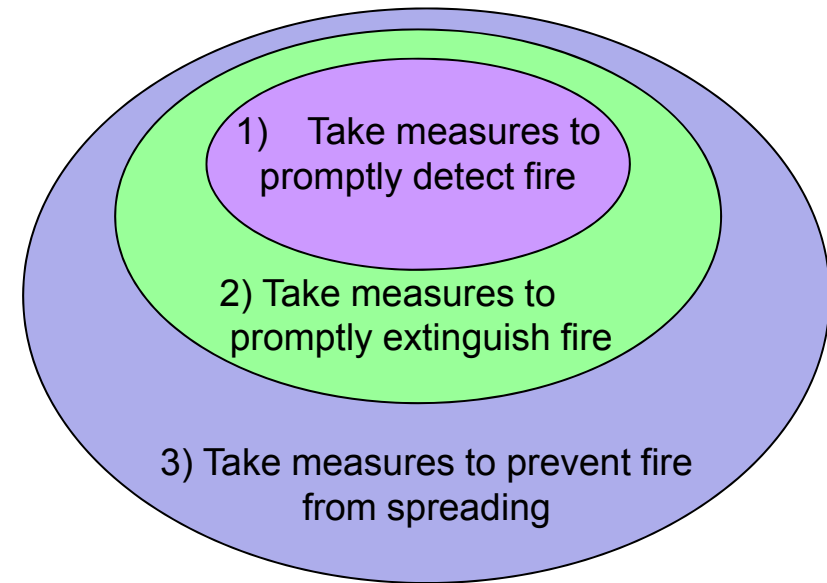

Measures to Prevent Recurrence (Applied to the Electrical Room)

1) Measures to promptly detect fire

【Measures】

- Install smoke detectors to detect the occurrence of smoke inside control panel more promptly.
- Install heat detectors on the cable racks in the electrical room and the tunnel to continuously monitor the temperature.
- Install monitoring cameras to promptly identify the abnormal point and inspect the place where trouble is detected.

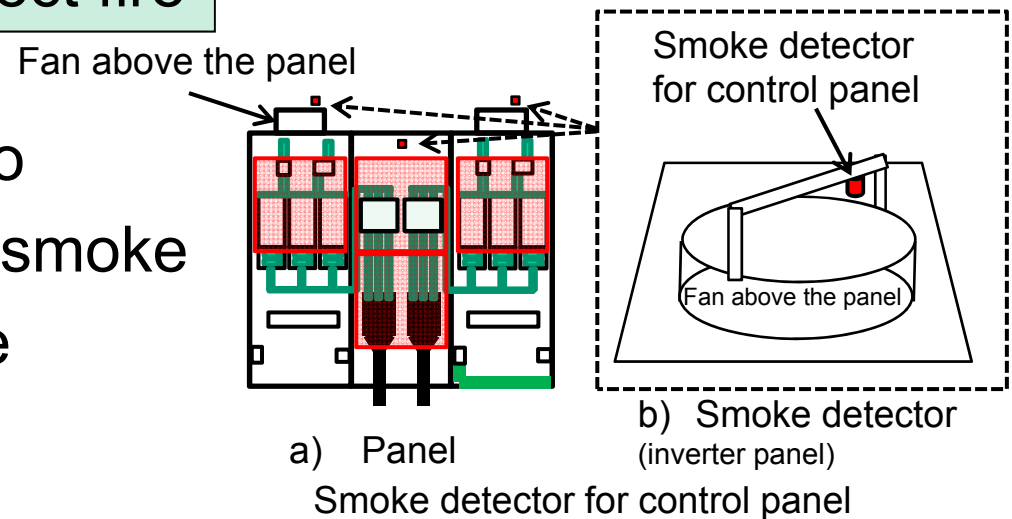

Measures to Prevent Recurrence (Applied to the Electrical Room)

2) Measures to promptly extinguish fire

【Measures】

- Install additional fire extinguishers beyond legal requirement.
- Install halon injection equipment for extinguishing fire inside the panels.
- Install additional fire hydrants within the building.
- Install overall electricity shutdown device in the operation room so that an operator can shut off electricity more promptly.
- Enlarge smoke-exhaust windows to facilitate smoke release.

 Smoke-exhaust window

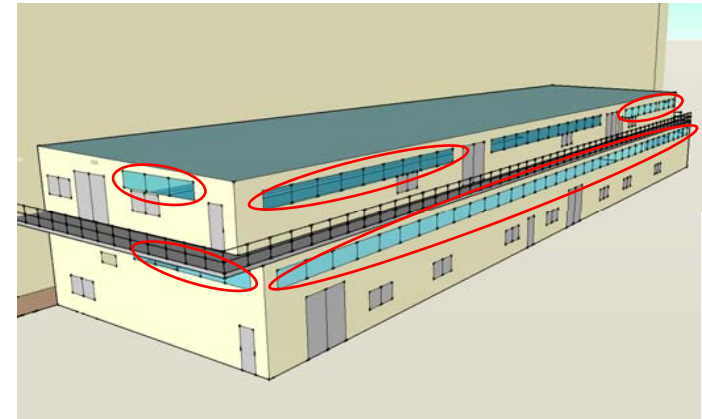

Image of thyristor room for auxiliary rolling equipment (After restoration)

Measures to Prevent Recurrence (Applied to the Electrical Room)

3) Measures to prevent fire from spreading

【Measures】

- Replace acrylic boards that caught fire with flame-retardant materials (vinyl chloride)
- Install dividers between panels.
- Ensure adequate space between panels and cables.
- Install sprinkler system for cable racks.

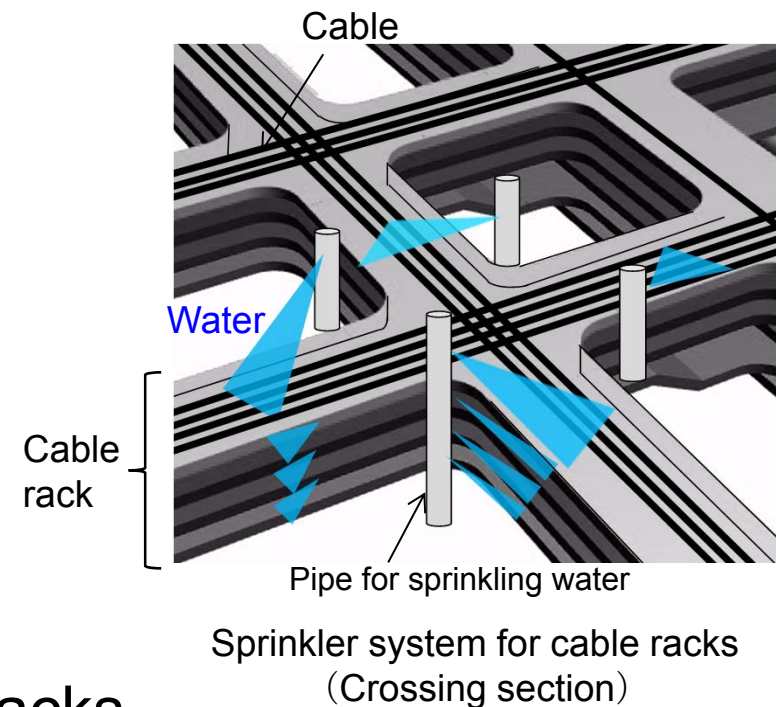

Measures to Prevent Recurrence (Corporate-wide)

- 1) We are promoting the application of necessary measures to each electrical room, referring to the measures applied to the electrical room of the plate mill in the Oita Works. (We have conducted an urgent check of similar facilities across the company promptly after the fire.)
- 2) We are enhancing measures such as conducting initial reaction drills and ensuring strict compliance with initial reaction manuals.

Future Schedule

- Plans for facility restoration and resumption of operation

We are devoting every effort to restore facilities and take measures to prevent similar accidents.

Currently, we are aiming at resuming operation in early August 2017 (originally, the expected timing of resuming operation was September 2017).